

Coaxial D-SUB 27W2 MALE Solder Cup

ROHS COMPLIANT

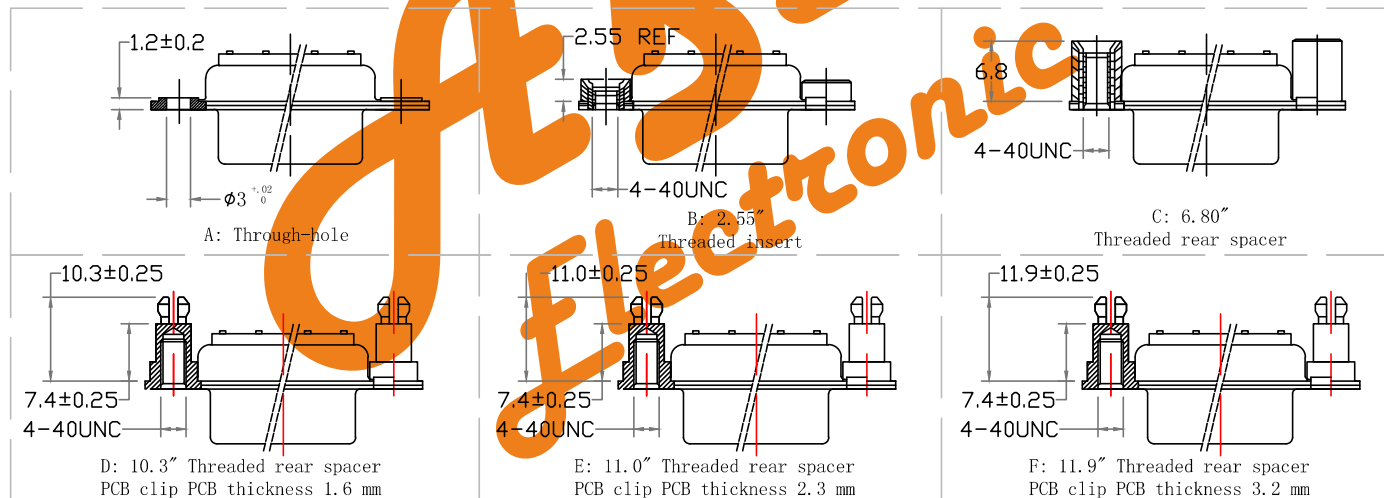
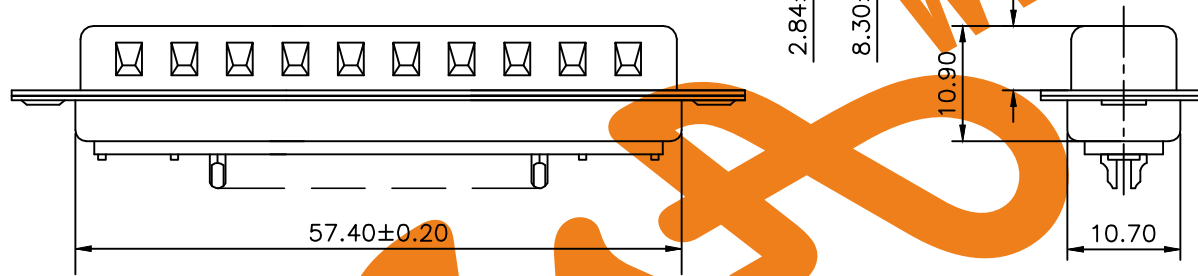
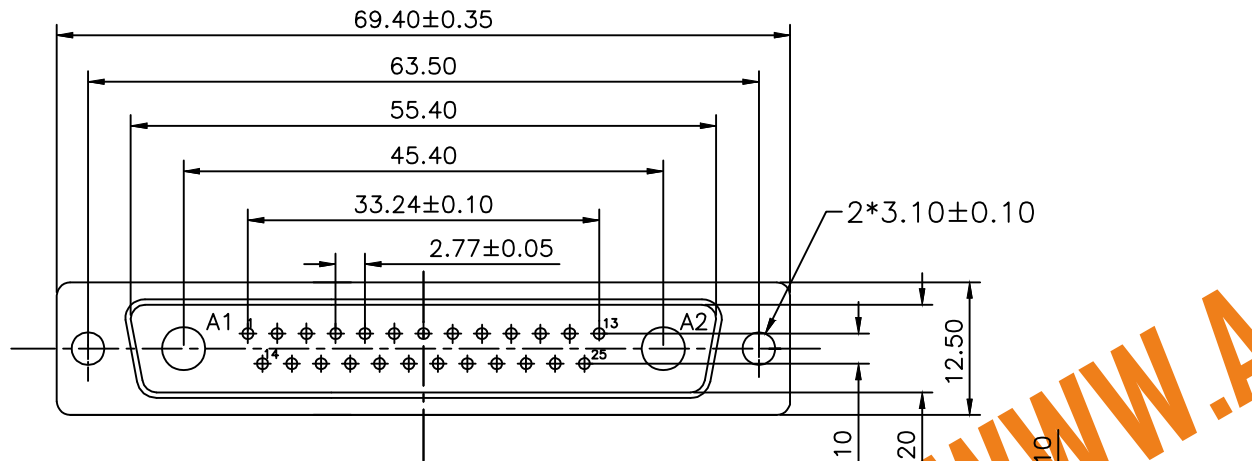

ELECTRICAL CHARACTERISTICS:

Dielectric withstanding Voltage: AC 1000V r.m.s.
 Insulation Resistance: 500 Megohms Minimum at DC 500V
 Contact Resistance: 25 Milliohms
 Operating Temperature: -20°C ~ +85°C

MATERIALS:

Insulator: PBT, UL 94V-0 Rated
 Shell: Cold Roller Steel

Ordering Code:

PDC27W2 -M -G0 -B -X -00
 ① ② ③ ④ ⑤ ⑥

- ① Series
- ② Contact Type:
M: Male F: Female
- ③ Contact NO.:
G0: Gold flash G1: 3u" Gold
G2: 5u" Gold G3: 10u" Gold
G4: 15u" Gold G5: 30u" Gold
- ④ Insulation Color Code:
B: Black L: Blue
W: White
- ⑤ Mounting Option:
A: Through-hole
B: 2.55" Threaded insert
C: 6.80" Threaded rear spacer
D: 10.3" Threaded rear spacer
E: 11.0" Threaded rear spacer
F: 11.9" Threaded rear spacer
PCB clip
- ⑥ Series

Unless Otherwise specified tolerance
 X.±0.35
 X.X:±0.25
 X.XX:±0.20
 X.XXX:±0.15

AsA Electronic WWW.AsA-Elec.com

AsA Electronic Co.

Tel : (+98) 21 66 73 56 82 Mob : (+98) 912 03 161 02

SCALE: 1:1

UNIT:
mm

DRAWN: junfon H

CHECKED: YANG

TITLE:

Coaxial D-SUB 27W2 MALE Solder Cup

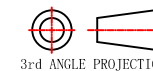

DRAWING NO: PDC27W2-MXXXX00

PRODUCT NO: PDC27W2-MXXXX00

Add option of plating

12/7/17

REV

DESCRIPTION

DATE

1

2

3

4

5

6

7

8